



ELP012C0350LSD1

Constant Current Dimmable Power Supply

Primary Dimmable with TRIAC Dimmer

350mA Const. / 22~34VDC / 8~12W



I. Technical Data

INPUT	
Input voltage range	176-264VAC
Rated input voltage	220~240VAC
Input frequency	50/60Hz
Input current	0,12A max.
Inrush current	10A max.(@230VAC)
Power factor	≥0,9 (@230VAC, Full load)
OUTPUT	
Output voltage	22-34VDC
No-load voltage	43VDC max.
Output current	const. 350mA
Current accuracy	±3%
Current ripple	<140mA p-p
Load range	8-12W
Efficiency	≥80% (@230VAC, Full load)
No load losses	≤1W
Start-up time	<1S
Dimmable	Primary dimmable with leading / trailing edge dimmer
Dimming range	10%-100%
MECHANIC & ENVIRONMENT	
Connection	Terminal block connection
Protection class	IP20
Surface temperature (Tc.)	+80°C max.
Operating temperature (Ta.)	-10°C~+50°C
Storage temperature	-10°C~+60°C
Humidity	10%-95%RH
Lifetime	≥ 50000 hours (@ 25°C, Full load)
Dimension	s. dimension diagram
PROTECTION	
Insulation class	Class II, SELV

Insulation resistor	IN-OUT:>4MΩ
Short circuit protection	Recovery after fault removed and restart
Over load protection	Recovery after fault removed and restart
Over temperature protection	Recovery after fault removed and restart
Electric strength	IN-OUT: 3750VAC/5mA/1 min
STANDARD	
Low Voltage Directive (LVD)	EN 61347-1; EN61347-2-13; EN60598-1; EN60598-2-6
EMC	EN55015; EN61547; EN61000-3-2 ; EN61000-3-3
Approvals / Certificate	CE, INTERTEK SEMO pending
RoHS compatible	Yes

II. Dimension

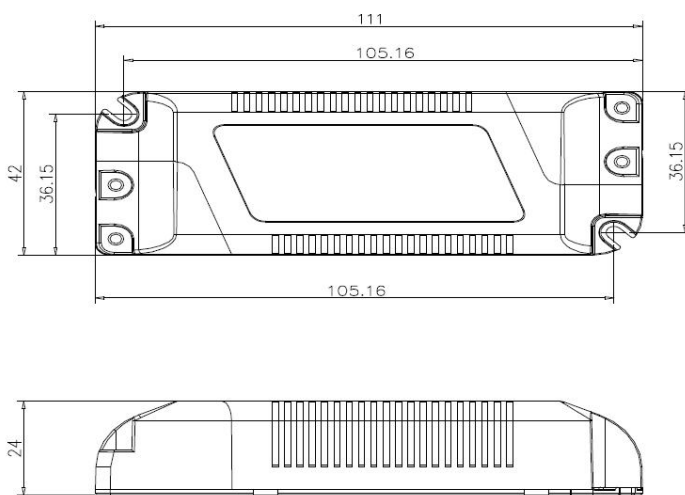

Unit: mm